

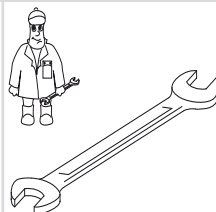

Gebr. Becker GmbH
Hölker Feld 29-31
D-42279 Wuppertal

Wartung
Maintenance
Entretien
Manutenzione
Mantenimiento



	Pos.	Menge ²⁾ Quantity Quantité Quantità Cantidad	Bestell-Nr. Ident No. No. Identification No. Identificazione No. de pedido	Bezeichnung Description Designation Designazione Descripción
DT 4.25/0-80	24	SATZ (KIT)	901349 00007	Schieber, Rotor Vane, Palette, Empujador
	72	1	909505 00000	Filterpatrone, Filter cartridge, Cartouche Filtrante, Cartuccia filtro, Cartucho de filtro
	74	1	909529 00000	Filterpatrone, Filter cartridge, Cartouche Filtrante, Cartuccia filtro, Cartucho de filtro
DT 4.40/0-80	24	SATZ (KIT)	901352 00007	Schieber, Rotor Vane, Palette, Empujador
	72	1	909505 00000	Filterpatrone, Filter cartridge, Cartouche Filtrante, Cartuccia filtro, Cartucho de filtro
	74	1	909529 00000	Filterpatrone, Filter cartridge, Cartouche Filtrante, Cartuccia filtro, Cartucho de filtro

²⁾ erforderliche Bestellmenge / necessary order quantity / quantité nécessaire / quantità di ordinazione necessari / cantidad necesario



Ersatzteilliste
Spare parts list
Liste de pièces de rechange
Listino pezzi di ricambio
Lista de piezas de recambio
Lista de peças sobresselentes
Reserveonderdelenlijst
Reservedelsliste
Reservdelslista

Reservedelsliste
Varaosaluettelo
Wykaz części zamiennych
Seznam náhradních dílů
Tartalékalkatrész lista
Κατάλογος ανταλλακτικών
Перечень запасных частей
备用零件目录
スペアパーツリスト

DT 4.25/0-80

DT 4.40/0-80



28000027511 07/2009

SERVICE

BECKER
D-42279 Wuppertal
www.becker-international.com

year

No. **B**

type **DT 4.25/0-80**

frequency Hz

speed min⁻¹

power required kW

inlet capacity m³/h

pressure + mbar

vacuum - mbar

Made in Germany

Index
Option

D Service:

Tel: +49 (0)202 697-171

Fax: +49 (0)202 64 44 74

E-Mail: info@becker-international.com

www.becker-international.com

B
Index

DT 4.25/0-80

Pos.	Bestell Nr.	Beschreibung	
15	020000 16400	KOLBEN	
16	016800 16500	SPANNSCHEIBE	
17	911012 00000	STAR-TOLERANZRING	
18	949203 00000	ZAHNSCHEIBE	
19	945320 00000	INNENSECHSKANTSCHRAUBE	
21	000100 16400	GEHÄUSE	
22	951806 00000	SPANNHÜLSE	
23	945320 00000	INNENSECHSKANTSCHRAUBE	
24	901349 00007	SCHIEBER, KOHLE (SATZ)	
25	952009 00000	SPANNHÜLSE	
28	000700 16500	SEITENDECKEL	
29	945373 00000	INNENSECHSKANTSCHRAUBE	
30	008900 16500	DICHTUNG	
46	502301 16400	VENTILATOR	
48	947713 00000	PASSFEDER	
49	949454 00000	UNTERLEGSCHLEIBE	
50	901804 00000	WELLENENDSCHRAUBE	
61	004803 27600	FILTERDECKEL	
67	009000 16300	ANPRESSFEDER	
72	909505 00000	FILTERPATRONE C 75/2 (1x) ¹⁾	
74	909529 00000	FILTERPATRONE C78/6 (1x) ¹⁾	
76	945373 00000	INNENSECHSKANTSCHRAUBE	
77	948021 00000	DICHTRING	
83	006807 27500	GERÄTEHAUBE	
85	951920 00000	GUMMIFORMTEIL	
88	006802 27600	GERÄTEHAUBE	
89	741365 00000	GUMMIPUFFER	
90	945318 00000	INNENSECHSKANTSCHRAUBE	
91	951922 00000	GUMMIFORMTEIL	
92	964110 00000	KANTENSCHUTZ	
94	015100 27600	FUSS	
95	951921 00000	GUMMIFORMTEIL	
96	068000 27600	DISTANZSTÜCK	
97	945328 00000	INNENSECHSKANTSCHRAUBE	
98	949451 00000	UNTERLEGSCHLEIBE	
101	833903 99597	VENTILTELLER	
102	951906 00000	KABELTÜLLE	
103	068002 16500	DISTANZROHR	
104	548800 16300	RINGSCHRAUBE	
125	728002 99611	DRUCKREGULIERVENTIL	
126	943132 00000	ANSAUGDÜSE	
135	951225 00000	VERSCHLUSSSCHRAUBE	

¹⁾ erforderliche Bestellmenge / Wartung

DT 4.25/0-80 (1~) Ausführung - Einphasenwechselstrom

Abweichende Positionen zum Standardgerät - siehe Anhang (Zeichnungsrückseite) 

OPTIONAL

A
Index

DT 4.40/0-80

Pos.	Bestell Nr.	Beschreibung	
15	020000 16500	KOLBEN	
16	016800 16500	SPANNSCHEIBE	
17	911008 00000	STAR-TOLERANZRING	
18	949203 00000	ZAHNSCHEIBE	
19	945320 00000	INNENSECHSKANTSCHRAUBE	
21	000100 16500	GEHÄUSE	
22	951806 00000	SPANNHÜLSE	
23	945322 00000	INNENSECHSKANTSCHRAUBE	
24	901352 00007	SCHIEBER, KOHLE (SATZ)	
25	952009 00000	SPANNHÜLSE	
28	000700 16500	SEITENDECKEL	
29	945374 00000	INNENSECHSKANTSCHRAUBE	
30	008900 16500	DICHTUNG	
46	902300 26200	VENTILATOR	
48	947713 00000	PASSFEDER	
49	949454 00000	UNTERLEGSCHLEIBE	
50	901804 00000	WELLENENDSCHRAUBE	
61	004803 27600	FILTERDECKEL	
67	009000 16300	ANPRESSFEDER	
72	909505 00000	FILTERPATRONE C 75/2 (1x) ¹⁾	
74	909529 00000	FILTERPATRONE C78/6 (1x) ¹⁾	
76	945373 00000	INNENSECHSKANTSCHRAUBE	
77	948021 00000	DICHTRING	
83	006806 27600	GERÄTEHAUBE	
85	951920 00000	GUMMIFORMTEIL	
88	006802 27600	GERÄTEHAUBE	
89	741365 00000	GUMMIPUFFER	
90	945318 00000	INNENSECHSKANTSCHRAUBE	
91	951922 00000	GUMMIFORMTEIL	
92	964109 00000	KANTENSCHUTZ	
94	015100 27600	FUSS	
95	951921 00000	GUMMIFORMTEIL	
96	068000 27600	DISTANZSTÜCK	
97	945328 00000	INNENSECHSKANTSCHRAUBE	
98	949451 00000	UNTERLEGSCHLEIBE	
101	833903 99597	VENTILTELLER	
102	951906 00000	KABELTÜLLE	
103	068002 16500	DISTANZROHR	
104	548800 16300	RINGSCHRAUBE	
125	728002 99611	DRUCKREGULIERVENTIL	
126	943133 00000	ANSAUGDÜSE	
135	951225 00000	VERSCHLUSSSCHRAUBE	

¹⁾ erforderliche Bestellmenge / Wartung

DT 4.40/0-80 (1~) Ausführung - Einphasenwechselstrom

Abweichende Positionen zum Standardgerät - siehe Anhang (Zeichnungsrückseite) 

OPTIONAL

B
Index

DT 4.25/0-80

Pos.	Ident No.	Description	
15	020000 16400	ROTOR	
16	016800 16500	CLAMPING DISC	
17	911012 00000	STAR-TOLERANCE-RING	
18	949203 00000	TOOTHED SPRING WASHER	
19	945320 00000	SOCKET HEAD SCREW	
21	000100 16400	PUMP BODY	
22	951806 00000	LOCATING PEG	
23	945320 00000	SOCKET HEAD SCREW	
24	901349 00007	CARBON VANES (KIT)	
25	952009 00000	LOCATING PEG	
28	000700 16500	LID	
29	945373 00000	SOCKET HEAD SCREW	
30	008900 16500	GASKET	
46	502301 16400	FAN	
48	947713 00000	KEY	
49	949454 00000	WASHER	
50	901804 00000	SHAFT END BOLD	
61	004803 27600	FILTER COVER	
67	009000 16300	LEAF SPRING	
72	909505 00000	FILTER CARTRIDGE C 75/2 (1x)¹⁾	
74	909529 00000	FILTER CARTRIDGE C78/6 (1x)¹⁾	
76	945373 00000	SOCKET HEAD SCREW	
77	948021 00000	SEALING RING	
83	006807 27500	PROTECTING HOOD	
85	951920 00000	RUBBER ELEMENT	
88	006802 27600	PROTECTING HOOD	
89	741365 00000	RUBBER BUFFER	
90	945318 00000	SOCKET HEAD SCREW	
91	951922 00000	RUBBER ELEMENT	
92	964110 00000	EDGE PROTECTION	
94	015100 27600	FOOT	
95	951921 00000	RUBBER ELEMENT	
96	068000 27600	SPACING COLLAR	
97	945328 00000	SOCKET HEAD SCREW	
98	949451 00000	WASHER	
101	833903 99597	VALVE DISC	
102	951906 00000	RUBBER BUSHING	
103	068002 16500	SPACER TUBE	
104	548800 16300	RING SCREW	
125	728002 99611	PRESSURE REGULATING VALVE	
126	943132 00000	SUCTION NOZZLE	
135	951225 00000	SCREW PLUG	

¹⁾ necessary order quantity / maintenance

DT 4.25/0-80 (1~) Design - single-phase AC

Items different from standard appliance see appendix (back of drawing) 

OPTIONAL

A
Index

DT 4.40/0-80

Pos.	Ident No.	Description	
15	020000 16500	ROTOR	
16	016800 16500	CLAMPING DISC	
17	911008 00000	STAR-TOLERANCE-RING	
18	949203 00000	TOOTHED SPRING WASHER	
19	945320 00000	SOCKET HEAD SCREW	
21	000100 16500	PUMP BODY	
22	951806 00000	LOCATING PEG	
23	945322 00000	SOCKET HEAD SCREW	
24	901352 00007	CARBON VANES (KIT)	
25	952009 00000	LOCATING PEG	
28	000700 16500	LID	
29	945374 00000	SOCKET HEAD SCREW	
30	008900 16500	GASKET	
46	902300 26200	FAN	
48	947713 00000	KEY	
49	949454 00000	WASHER	
50	901804 00000	SHAFT END BOLD	
61	004803 27600	FILTER COVER	
67	009000 16300	LEAF SPRING	
72	909505 00000	FILTER CARTRIDGE C 75/2 (1x)¹⁾	
74	909529 00000	FILTER CARTRIDGE C78/6 (1x)¹⁾	
76	945373 00000	SOCKET HEAD SCREW	
77	948021 00000	SEALING RING	
83	006806 27600	PROTECTING HOOD	
85	951920 00000	RUBBER ELEMENT	
88	006802 27600	PROTECTING HOOD	
89	741365 00000	RUBBER BUFFER	
90	945318 00000	SOCKET HEAD SCREW	
91	951922 00000	RUBBER ELEMENT	
92	964109 00000	EDGE PROTECTION	
94	015100 27600	FOOT	
95	951921 00000	RUBBER ELEMENT	
96	068000 27600	SPACING COLLAR	
97	945328 00000	SOCKET HEAD SCREW	
98	949451 00000	WASHER	
101	833903 99597	VALVE DISC	
102	951906 00000	RUBBER BUSHING	
103	068002 16500	SPACER TUBE	
104	548800 16300	RING SCREW	
125	728002 99611	PRESSURE REGULATING VALVE	
126	943133 00000	SUCTION NOZZLE	
135	951225 00000	SCREW PLUG	

¹⁾ necessary order quantity / maintenance

DT 4.40/0-80 (1~) Design - single-phase AC

Items different from standard appliance see appendix (back of drawing) 

OPTIONAL

B
Index

DT 4.25/0-80

Pos.	No. Identification	Designation
15	020000 16400	PISTON
16	016800 16500	DISQUE DE SERRAGE
17	911012 00000	BAGUE STAR
18	949203 00000	DENT DISQUE
19	945320 00000	VIS HEXAGONALE INTERNE
21	000100 16400	CORP DE POMPE
22	951806 00000	DOUILLE DE ETRAGE
23	945320 00000	VIS HEXAGONALE INTERNE
24	901349 00007	PALETTE DE CHARBON (KIT)
25	952009 00000	DOVILLE DE ETRAGE
28	000700 16500	COUVERCLE
29	945373 00000	VIS HEXAGONALE INTERNE
30	008900 16500	JOINT
46	502301 16400	VENTILATEUR
48	947713 00000	CLAVETTE
49	949454 00000	RONDELLE
50	901804 00000	VIS BOUT D'ARBRE
61	004803 27600	COUVERCLE DU FILTRE
67	009000 16300	RESSORT-JAME
72	909505 00000	CARTOUCHE FILTRANTE C 75/2 (1x)¹⁾
74	909529 00000	CARTOUCHE FILTRANTE C78/6 (1x)¹⁾
76	945373 00000	VIS HEXAGONALE INTERNE
77	948021 00000	JOINT
83	006807 27500	CARTER PROTECTEUR
85	951920 00000	ELEMENT EN CAOUTCHOUC
88	006802 27600	CARTER PROTECTEUR
89	741365 00000	AMORTISSEUR EN CAOUTCHOUC
90	945318 00000	VIS HEXAGONALE INTERNE
91	951922 00000	ELEMENT EN CAOUTCHOUC
92	964110 00000	PROTECTION D'ARETE
94	015100 27600	PIED
95	951921 00000	ELEMENT EN CAOUTCHOUC
96	068000 27600	DONILLE D'ECARMENT
97	945328 00000	VIS HEXAGONALE INTERNE
98	949451 00000	RONDELLE
101	833903 99597	PLATEAU DE SOUPE
102	951906 00000	PROTECTION EN CAOUTCHOUC
103	068002 16500	TUBE D'ECARTEMENT
104	548800 16300	PITON
125	728002 99611	SOUPE REGLAGE PRESSION
126	943132 00000	AJUTAGE
135	951225 00000	BOUCHON FILETÉ

¹⁾ quantité nécessaire / entretien

DT 4.25/0-80 (1~) Fabrication - AC monophasé

Articles divergents vis-à-vis de l'appareil standard, voir annexe (dos du dessin / du plan) 

EN OPTION

A
Index

DT 4.40/0-80

Pos.	No. Identification	Designation
15	020000 16500	PISTON
16	016800 16500	DISQUE DE SERRAGE
17	911008 00000	BAGUE STAR
18	949203 00000	DENT DISQUE
19	945320 00000	VIS HEXAGONALE INTERNE
21	000100 16500	CORP DE POMPE
22	951806 00000	DOUILLE DE ETRAGE
23	945322 00000	VIS HEXAGONALE INTERNE
24	901352 00007	PALETTE DE CHARBON (KIT)
25	952009 00000	DOVILLE DE ETRAGE
28	000700 16500	COUVERCLE
29	945374 00000	VIS HEXAGONALE INTERNE
30	008900 16500	JOINT
46	902300 26200	VENTILATEUR
48	947713 00000	CLAVETTE
49	949454 00000	RONDELLE
50	901804 00000	VIS BOUT D'ARBRE
61	004803 27600	COUVERCLE DU FILTRE
67	009000 16300	RESSORT-JAME
72	909505 00000	CARTOUCHE FILTRANTE C 75/2 (1x)¹⁾
74	909529 00000	CARTOUCHE FILTRANTE C78/6 (1x)¹⁾
76	945373 00000	VIS HEXAGONALE INTERNE
77	948021 00000	JOINT
83	006806 27600	CARTER PROTECTEUR
85	951920 00000	ELEMENT EN CAOUTCHOUC
88	006802 27600	CARTER PROTECTEUR
89	741365 00000	AMORTISSEUR EN CAOUTCHOUC
90	945318 00000	VIS HEXAGONALE INTERNE
91	951922 00000	ELEMENT EN CAOUTCHOUC
92	964109 00000	PROTECTION D'ARETE
94	015100 27600	PIED
95	951921 00000	ELEMENT EN CAOUTCHOUC
96	068000 27600	DONILLE D'ECARMENT
97	945328 00000	VIS HEXAGONALE INTERNE
98	949451 00000	RONDELLE
101	833903 99597	PLATEAU DE SOUPE
102	951906 00000	PROTECTION EN CAOUTCHOUC
103	068002 16500	TUBE D'ECARTEMENT
104	548800 16300	PITON
125	728002 99611	SOUPE REGLAGE PRESSION
126	943133 00000	AJUTAGE
135	951225 00000	BOUCHON FILETÉ

¹⁾ quantité nécessaire / entretien

DT 4.40/0-80 (1~) Fabrication - AC monophasé

Articles divergents vis-à-vis de l'appareil standard, voir annexe (dos du dessin / du plan) 

EN OPTION

B
Index**DT 4.25/0-80**

Pos.	No. Identificazione	Designazione	
15	020000 16400	ROTORE	
16	016800 16500	DISCO DI FISSAGGIO	
17	911012 00000	STAR-ANELLO TOLLERANZA	
18	949203 00000	DISCO A DENTE	
19	945320 00000	VITE ESAGONALE INTERNA	
21	000100 16400	CARASSA	
22	951806 00000	SPINE DI RISCONTRO	
23	945320 00000	VITE ESAGONALE INTERNA	
24	901349 00007	PALETTE DI CHARBONE (KIT)	
25	952009 00000	SPINE DI RISCONTRO	
28	000700 16500	COPERCHIO	
29	945373 00000	VITE ESAGONALE INTERNA	
30	008900 16500	GUARNIZIONE	
46	502301 16400	VENTILATORE	
48	947713 00000	CHIAVETTA	
49	949454 00000	RONDELLA	
50	901804 00000	VITE DI CHIUSURA ALBERO	
61	004803 27600	COPERCHIO FILTRO	
67	009000 16300	MOLLA	
72	909505 00000	CARTUCCIA FILTRO C 75/2 (1x)¹⁾	
74	909529 00000	CARTUCCIA FILTRO C78/6 (1x)¹⁾	
76	945373 00000	VITE ESAGONALE INTERNA	
77	948021 00000	ANELLO GUARNIZIONE	
83	006807 27500	CARTER DI PROTEZIONE	
85	951920 00000	ELEMENTO IN GOMMA	
88	006802 27600	CARTER DI PROTEZIONE	
89	741365 00000	AMMORTIZZATORE IN GOMMA	
90	945318 00000	VITE ESAGONALE INTERNA	
91	951922 00000	ELEMENTO IN GOMMA	
92	964110 00000	LISTELLO DI PROTEZIONE	
94	015100 27600	PIEDE	
95	951921 00000	ELEMENTO IN GOMMA	
96	068000 27600	BOCCOLA DISTANZIATRICE	
97	945328 00000	VITE ESAGONALE INTERNA	
98	949451 00000	RONDELLA	
101	833903 99597	PIATTELLO DELLA VALVOLA	
102	951906 00000	PROTEZIONE IN GOMMA	
103	068002 16500	TUBO DISTANZA	
104	548800 16300	GANCIO	
125	728002 99611	VALVOLA REGOLARE PRESSIONE	
126	943132 00000	UGELLO	
135	951225 00000	TAPPO A VITE	

¹⁾ quantità di ordinazione necessari / manutenzione**DT 4.25/0-80** (1~) Versión - AC monofásicaVedere allegato (retro del disegno) per le posizioni divergenti dall'apparecchio standard 

OPTIONALE

A
Index**DT 4.40/0-80**

Pos.	No. Identificazione	Designazione	
15	020000 16500	ROTORE	
16	016800 16500	DISCO DI FISSAGGIO	
17	911008 00000	STAR-ANELLO TOLLERANZA	
18	949203 00000	DISCO A DENTE	
19	945320 00000	VITE ESAGONALE INTERNA	
21	000100 16500	CARASSA	
22	951806 00000	SPINE DI RISCONTRO	
23	945322 00000	VITE ESAGONALE INTERNA	
24	901352 00007	PALETTE DI CHARBONE (KIT)	
25	952009 00000	SPINE DI RISCONTRO	
28	000700 16500	COPERCHIO	
29	945374 00000	VITE ESAGONALE INTERNA	
30	008900 16500	GUARNIZIONE	
46	902300 26200	VENTILATORE	
48	947713 00000	CHIAVETTA	
49	949454 00000	RONDELLA	
50	901804 00000	VITE DI CHIUSURA ALBERO	
61	004803 27600	COPERCHIO FILTRO	
67	009000 16300	MOLLA	
72	909505 00000	CARTUCCIA FILTRO C 75/2 (1x)¹⁾	
74	909529 00000	CARTUCCIA FILTRO C78/6 (1x)¹⁾	
76	945373 00000	VITE ESAGONALE INTERNA	
77	948021 00000	ANELLO GUARNIZIONE	
83	006806 27600	CARTER DI PROTEZIONE	
85	951920 00000	ELEMENTO IN GOMMA	
88	006802 27600	CARTER DI PROTEZIONE	
89	741365 00000	AMMORTIZZATORE IN GOMMA	
90	945318 00000	VITE ESAGONALE INTERNA	
91	951922 00000	ELEMENTO IN GOMMA	
92	964109 00000	LISTELLO DI PROTEZIONE	
94	015100 27600	PIEDE	
95	951921 00000	ELEMENTO IN GOMMA	
96	068000 27600	BOCCOLA DISTANZIATRICE	
97	945328 00000	VITE ESAGONALE INTERNA	
98	949451 00000	RONDELLA	
101	833903 99597	PIATTELLO DELLA VALVOLA	
102	951906 00000	PROTEZIONE IN GOMMA	
103	068002 16500	TUBO DISTANZA	
104	548800 16300	GANCIO	
125	728002 99611	VALVOLA REGOLARE PRESSIONE	
126	943133 00000	UGELLO	
135	951225 00000	TAPPO A VITE	

¹⁾ quantità di ordinazione necessari / manutenzione**DT 4.40/0-80** (1~) Modello - AC monofaseVedere allegato (retro del disegno) per le posizioni divergenti dall'apparecchio standard 

OPTIONALE

B
Index**DT 4.25/0-80**

Pos.	No. De pedido	Descripción	
15	020000 16400	ÉMBOLO	
16	016800 16500	ARANDELA TENSORA	
17	911012 00000	ANILLO DE TOLERANCIA STAR	
18	949203 00000	POLEA DENTADA	
19	945320 00000	TORNILLO HEXAGONAL INTERIOR	
21	000100 16400	CARCASA	
22	951806 00000	CASQUILLO TENSOR	
23	945320 00000	TORNILLO HEXAGONAL INTERIOR	
24	901349 00007	EMPUJADOR DE CARBÓN (KIT)	
25	952009 00000	CASQUILLO TENSOR	
28	000700 16500	TAPA LATERAL	
29	945373 00000	TORNILLO HEXAGONAL INTERIOR	
30	008900 16500	JUNTA	
46	502301 16400	VENTILADOR	
48	947713 00000	LENGÜETA DE AJUSTE	
49	949454 00000	ARANDELA	
50	901804 00000	TORNILLO TERMINAL DE ÁRBOL	
61	004803 27600	TAPA DE FILTRO	
67	009000 16300	MUELLE DE PRESIÓN	
72	909505 00000	CARTUCHO DE FILTRO C 75/2 (1x)¹⁾	
74	909529 00000	CARTUCHO DE FILTRO C78/6 (1x)¹⁾	
76	945373 00000	TORNILLO HEXAGONAL INTERIOR	
77	948021 00000	ANILLO DE JUNTA	
83	006807 27500	CAPERUZA DE APARATO	
85	951920 00000	PIEZA DE ORMA DE GOMA	
88	006802 27600	CAPERUZA DE APARATO	
89	741365 00000	AMORTIGUADOR DE GOMA	
90	945318 00000	TORNILLO HEXAGONAL INTERIOR	
91	951922 00000	PIEZA DE ORMA DE GOMA	
92	964110 00000	PROTECCIÓN DE CANTOS	
94	015100 27600	PIE	
95	951921 00000	PIEZA DE ORMA DE GOMA	
96	068000 27600	PIEZA DISTANCIADORA	
97	945328 00000	TORNILLO HEXAGONAL INTERIOR	
98	949451 00000	ARANDELA	
101	833903 99597	PLATILLO DE VÁLVULA	
102	951906 00000	BOQUILLA DE CABLE	
103	068002 16500	TUBO DISTANCIADOR	
104	548800 16300	TORNILLO DE CÁNCAMO	
125	728002 99611	VÁLVULA REGULADORA DE PRESIÓN	
126	943132 00000	TOBERA	
135	951225 00000	TAPÓN ROSCADO	

¹⁾ cantidad necesario / mantenimiento**DT 4.25/0-80** (1~) Versión - AC monofásicaPara posiciones que derivan del aparato standard véase apéndice (lado trasero del plano) 

OPCIONAL

A
Index**DT 4.40/0-80**

Pos.	No. De pedido	Descripción	
15	020000 16500	ÉMBOLO	
16	016800 16500	ARANDELA TENSORA	
17	911008 00000	ANILLO DE TOLERANCIA STAR	
18	949203 00000	POLEA DENTADA	
19	945320 00000	TORNILLO HEXAGONAL INTERIOR	
21	000100 16500	CARCASA	
22	951806 00000	CASQUILLO TENSOR	
23	945322 00000	TORNILLO HEXAGONAL INTERIOR	
24	901352 00007	EMPUJADOR DE CARBÓN (KIT)	
25	952009 00000	CASQUILLO TENSOR	
28	000700 16500	TAPA LATERAL	
29	945374 00000	TORNILLO HEXAGONAL INTERIOR	
30	008900 16500	JUNTA	
46	902300 26200	VENTILADOR	
48	947713 00000	LENGÜETA DE AJUSTE	
49	949454 00000	ARANDELA	
50	901804 00000	TORNILLO TERMINAL DE ÁRBOL	
61	004803 27600	TAPA DE FILTRO	
67	009000 16300	MUELLE DE PRESIÓN	
72	909505 00000	CARTUCHO DE FILTRO C 75/2 (1x)¹⁾	
74	909529 00000	CARTUCHO DE FILTRO C78/6 (1x)¹⁾	
76	945373 00000	TORNILLO HEXAGONAL INTERIOR	
77	948021 00000	ANILLO DE JUNTA	
83	006806 27600	CAPERUZA DE APARATO	
85	951920 00000	PIEZA DE ORMA DE GOMA	
88	006802 27600	CAPERUZA DE APARATO	
89	741365 00000	AMORTIGUADOR DE GOMA	
90	945318 00000	TORNILLO HEXAGONAL INTERIOR	
91	951922 00000	PIEZA DE ORMA DE GOMA	
92	964109 00000	PROTECCIÓN DE CANTOS	
94	015100 27600	PIE	
95	951921 00000	PIEZA DE ORMA DE GOMA	
96	068000 27600	PIEZA DISTANCIADORA	
97	945328 00000	TORNILLO HEXAGONAL INTERIOR	
98	949451 00000	ARANDELA	
101	833903 99597	PLATILLO DE VÁLVULA	
102	951906 00000	BOQUILLA DE CABLE	
103	068002 16500	TUBO DISTANCIADOR	
104	548800 16300	TORNILLO DE CÁNCAMO	
125	728002 99611	VÁLVULA REGULADORA DE PRESIÓN	
126	943133 00000	TOBERA	
135	951225 00000	TAPÓN ROSCADO	

¹⁾ cantidad necesario / mantenimiento**DT 4.40/0-80** (1~) Versión - AC monofásicaPara posiciones que derivan del aparato standard véase apéndice (lado trasero del plano) 

OPCIONAL

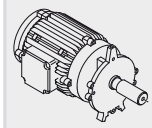

SERVICE ?

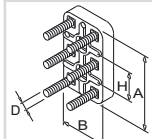
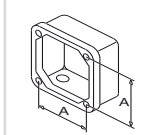
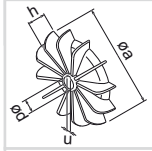

1~

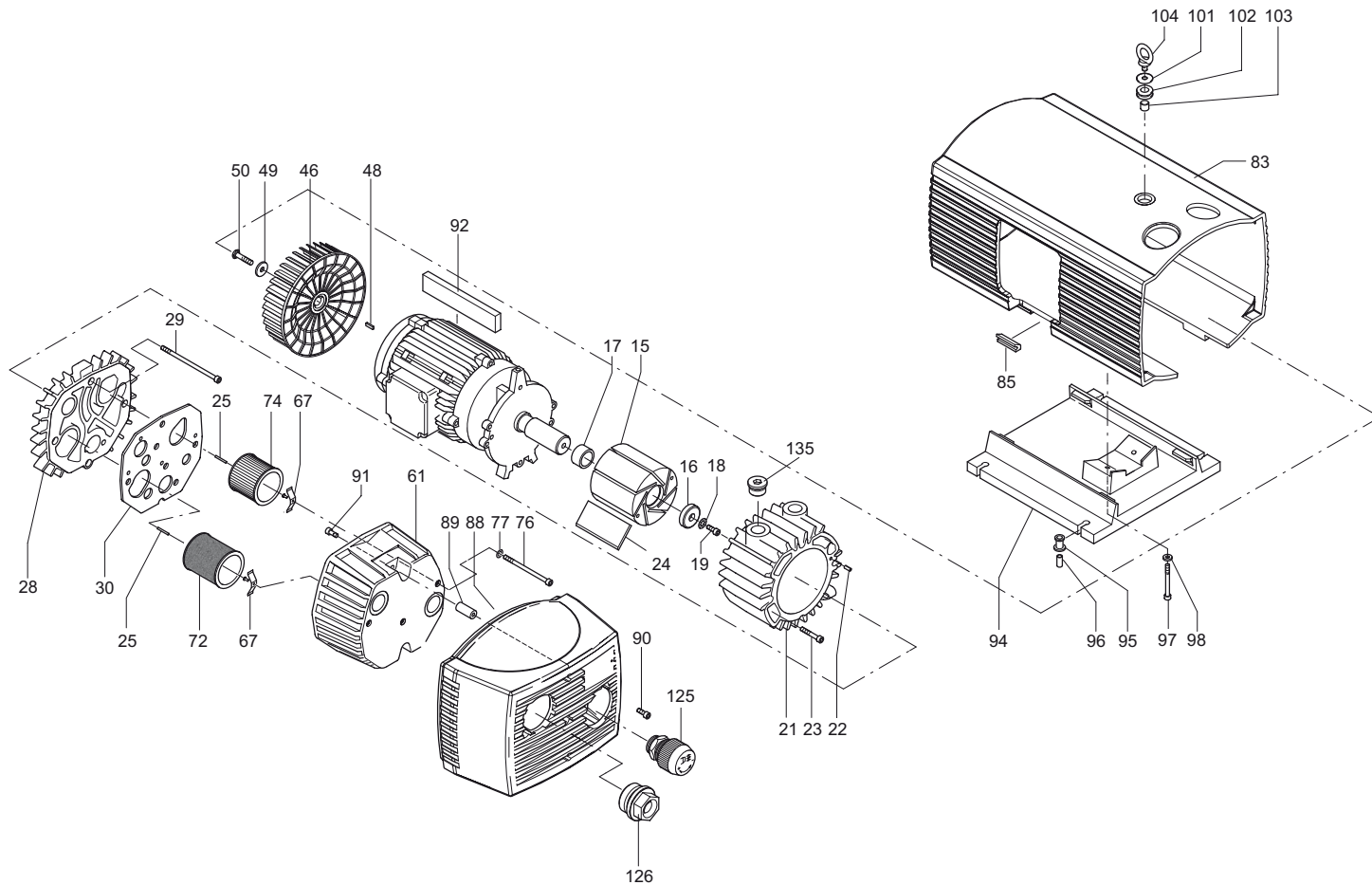
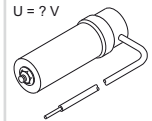

C = ? μ F
U = ? V



standard

DT 4.25/0-80 (3~)
DT 4.40/0-80 (3~)

optional
en option
opcionale
opcional

optional en option optionale opcional 	Variante(n) Modifications Variantes	Pos ²⁾	Bestell Nr. / Ident No. / No. Identification / No. Identificazione / No. De pedido		Beschreibung / Description / Designation / Designazione / Desripcion
					
DT 4.25/0-80 (1~) DT 4.40/0-80 (1~)	DT 4.25/0-80 (1~)	8 12 13 83 94	964233 00000 948766 00000 742002 30000 006808 27500 015101 27600	006807-27500 045100-27600	WINKEL / BRACKET / COUDES / GOMITO / ÁNGULO BLINDNIET / BLIND RIVET / RIVET AVEUGLIE / RIVETTO CIECO / REMACHE CIEGO KABEL / CABLE / CABLE / CAVO / CABLE HAUBE / PROTECTING HOOD / CARTER PROTECTEUR / CARTER DI PROTEZIONE / CAPERUZA FUSS / FOOT / PIED / PIEDE / PIE
	DT 4.40/0-80 (1~)	8 12 13 83 94	964233 00000 948766 00000 742002 30000 006810 27600 015101 27600	006806-27600 045100-27600	WINKEL / BRACKET / COUDES / GOMITO / ÁNGULO BLINDNIET / BLIND RIVET / RIVET AVEUGLIE / RIVETTO CIECO / REMACHE CIEGO KABEL / CABLE / CABLE / CAVO / CABLE HAUBE / PROTECTING HOOD / CARTER PROTECTEUR / CARTER DI PROTEZIONE / CAPERUZA FUSS / FOOT / PIED / PIEDE / PIE

²⁾ variantenabhängige Bauteile / variant-dependent components / composants variante-dependantes / componenti variante-dispendenti / componentes variante-dependientes